

Tuffcap electrodes consist of two pieces: a shank and a replaceable cap. These two-part electrodes can offer major economies, because when the nose geometry is worn out, only the cap needs to be replaced. And it costs far less than a standard one-piece electrode. (A Tuffcap shank will normally outlast twenty caps.) Also, electrode inventory can be kept small because all nose designs will fit the same size shank.

TWO TYPES: TUFFALOY offers two kinds of Tuffcap electrodes. One uses a male cap that fits into the shank. The other has a female cap that fits over the shank.

FEMALE AND MALE CAPS are available in the widest range of sizes, alloys, and styles. They are made in both Class 1 and Class 2 alloy, and in sizes to fit shanks sized 4 through 7 RW. Male caps are more effectively cooled than female caps.

ALL CAPS are made with the same nose designs in conformance with RWMA standards.

SHANKS are made of Class 2 alloy, either straight, or bent to provide an offset. Shanks other than those cataloged can be special ordered. Tuffcap, caps and shanks should be used only in a directly opposed, straight-line manner. They do not work as well as standard electrodes on heavily coated metal such as galvanized or tin-plate.

TUFFTRODE-Z CAPS FOR COATED STEELS

To avoid electrode sticking problems common when welding galvanized and aluminized materials, these copper chrome-zirconium alloy caps are offered. They give the same performance as dispersion-strengthened caps but cost far less. They are Class 2 caps in mechanical and physical properties.

Both male and female caps are offered in all the standard nose designs.

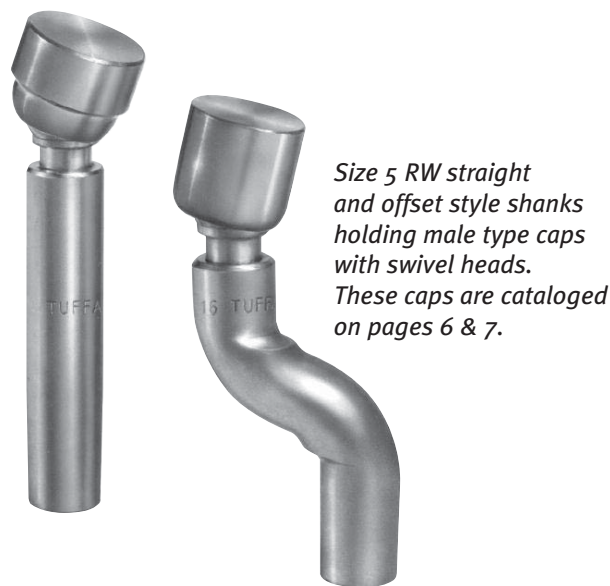
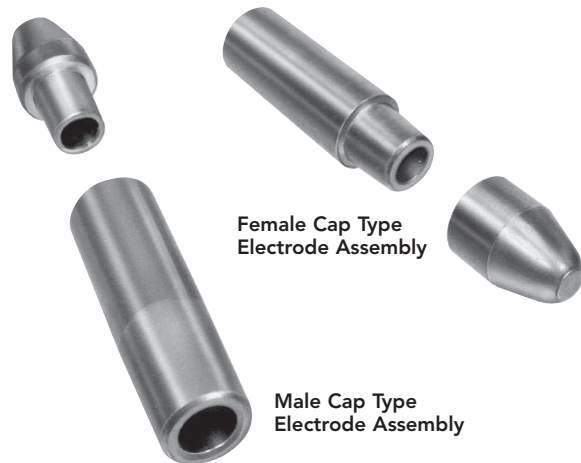

NEW! SUPER NOSE DESIGN CAPS

To avoid mushrooming and brassing problems associated with standard designs, these caps have a self-dressing weld face ring that acts as a control zone. The Super Nose caps are available in TUFFALOY's new "Z" material, that eliminates electrode sticking problems common when welding galvanized and aluminized materials.

Both male and female designs are offered, designed to fit shanks with 5 RW taper.

U.S. Patent Number 5,155,320
Other patents pending



TUFFALO CAPS AND SHANKS

STRAIGHT SHANKS FOR MALE CAPS (CLASS 2*)

SHANKS 4 RW TAPER

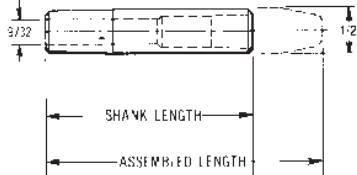

SHANKS 5 RW TAPER

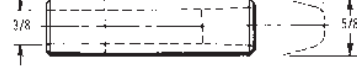

SHANKS 6 RW TAPER

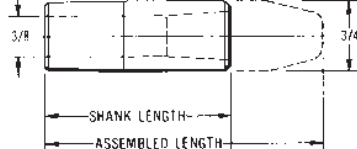

SHANKS 7 RW TAPER

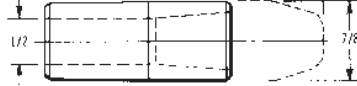

Shank Length	Assembled Length	Description	Part No.
1-1/4	2	TG-2405	161-2405
1-1/2	2-1/4	TG-2406	161-2406
1-3/4	2-1/2	TG-2407	161-2407
2	2-3/4	TG-2408	161-2408
2-1/4	3	TG-2409	161-2409
2-1/2	3-1/4	TG-2410	161-2410
2-3/4	3-1/2	TG-2411	161-2411
3	3-3/4	TG-2412	161-2412
3-1/4	4	TG-2413	161-2413

1-1/4	2	TG-2505	161-2505
1-1/2	2-1/4	TG-2506	161-2506
1-3/4	2-1/2	TG-2507	161-2507
2	2-3/4	TG-2508	161-2508
2-1/4	3	TG-2509	161-2509
2-1/2	3-1/4	TG-2510	161-2510
2-3/4	3-1/2	TG-2511	161-2511
3	3-3/4	TG-2512	161-2512
3-1/4	4	TG-2513	161-2513

1-1/2	2-1/2	TG-2606	161-2606
2	3	TG-2608	161-2608
2-1/2	3-1/2	TG-2610	161-2610
3	4	TG-2612	161-2612

1-1/2	2-1/2	TG-2706	161-2706
2	3	TG-2708	161-2708
2-1/2	3-1/2	TG-2710	161-2710
3	4	TG-2712	161-2712

'E' NOSE
4 AND 5 CAP



'F' NOSE
4 AND 5 CAP

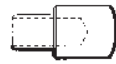

BENT SHANKS FOR MALE CAPS (CLASS 2*)

SHANKS 4 RW TAPER

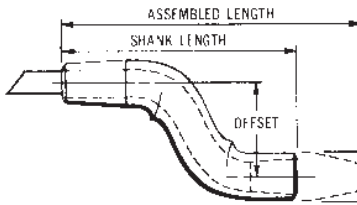

Shank Length	Off-set	Length	Description	Part No.
2-1/2	1/2	3-1/4	TG-2410-08	162-2410
2-1/2	3/4	3-1/4	TG-2410-12	162-2420
2-1/2	1	3-1/4	TG-2410-16	162-2430
3	1/2	3-3/4	TG-2412-8	162-2450
3	1-1/4	3-3/4	TG-2412-20	162-2460
3-1/4	1	4	TG-2413-16	162-2470
3-1/4	1-1/4	4	TG-2413-20	162-2480

SHANKS 5 RW TAPER

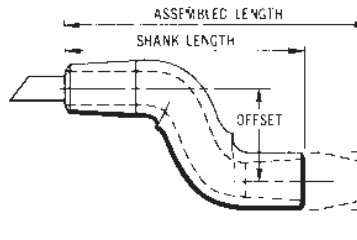

2-1/4	1/4	3	TG-2509-4	162-2505
2-1/2	1/2	3-1/4	TG-2510-8	162-2510
2-1/2	3/4	3-1/4	TG-2510-12	162-2520
2-1/2	1	3-1/4	TG-2510-16	162-2530
3	1/2	3-3/4	TG-2512-8	162-2550
3	1-1/4	3-3/4	TG-2512-20	162-2560
3-1/4	1	4	TG-2513-16	162-2570
3-1/4	1-1/4	4	TG-2513-20	162-2580

* Class 3 Available

MALE CAPS

POINTED TIPS 'A'

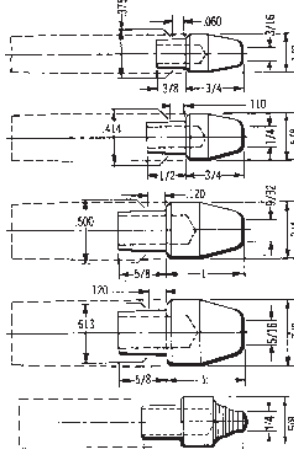

DOME TIPS 'B'

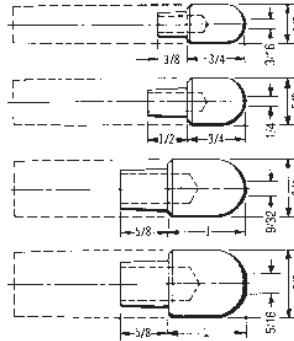

FLAT TIPS 'C'

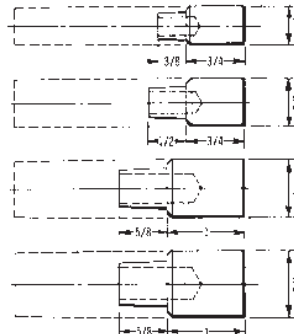

OFFSET TIPS 'D'

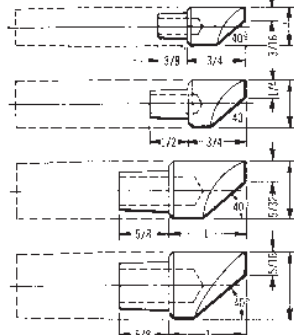

Alloy Class	Taper of Adapter Shank	Description	Part No.
1	4RW	TA-14	111-0014
2	4RW	TA-24	112-0024
3	4RW	TA-34	122-1034
1	5RW	TA-15	111-0015
1&2	5RW	TA-25Z	126-0025
2	5RW	TA-25	112-0025
3	5RW	TA-35	122-1035
1	6RW	TA-16	111-0016
2	6RW	TA-26	112-0026
1	7RW	TA-17	111-0017
2	7RW	TA-27	112-0027
Z	4RW	TS-24Z	127-0024
Z	5RW	TS-25Z	127-0025

1	4RW	TB-14	113-0014
2	4RW	TB-24	114-0024
1	5RW	TB-15	113-0015
2	5RW	TB-25	114-0025
1	6RW	TB-16	113-0016
2	6RW	TB-26	114-0026
1	7RW	TB-17	113-0017
2	7RW	TB-27	114-0027

1	4RW	TC-14	115-0014
2	4RW	TC-24	116-0024
3	4RW	TC-34	122-3034
1	5RW	TC-15	115-0015
2	5RW	TC-25	116-0025
3	5RW	TC-35	122-3035
1	6RW	TC-16	115-0016
2	6RW	TC-26	116-0026
1	7RW	TC-17	115-0017
2	7RW	TC-27	116-0027

1	4RW	TD-14	117-0014
2	4RW	TD-24	118-0024
3	4RW	TD-34	122-4034
1	5RW	TD-15	117-0015
2	5RW	TD-25	118-0025
3	5RW	TD-35	122-4035
1	6RW	TD-16	117-0016
2	6RW	TD-26	118-0026
1	7RW	TD-17	117-0017
2	7RW	TD-27	118-0027



STRAIGHT SHANKS FOR FEMALE CAPS (CLASS 2*)

SHANKS 4 RW TAPER

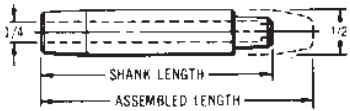

Shank Length	Assembled Length	Description	Part No.
1-1/2	2	TP-2406	163-2406
1-3/4	2-1/4	TP-2407	163-2407
2	2-1/2	TP-2408	163-2408
2-1/4	2-3/4	TP-2409	163-2409
2-1/2	3	TP-2410	163-2410
2-3/4	3-1/4	TP-2411	163-2411
3	3-1/2	TP-2412	163-2412
3-1/4	3-3/4	TP-2413	163-2413
3-1/2	4	TP-2414	163-2414

SHANKS 5 RW TAPER

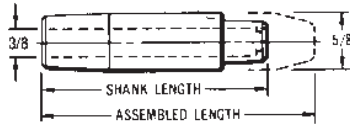

Shank Length	Assembled Length	Description	Part No.
1-1/2	2	TP-2506	163-2506
1-3/4	2-1/4	TP-2507	163-2507
2	2-1/2	TP-2508	163-2508
2-1/4	2-3/4	TP-2509	163-2509
2-1/2	3	TP-2510	163-2510
2-3/4	3-1/4	TP-2511	163-2511
3	3-1/2	TP-2512	163-2512
3-1/4	3-3/4	TP-2513	163-2513
3-1/2	4	TP-2514	163-2514

SHANKS 6 RW TAPER

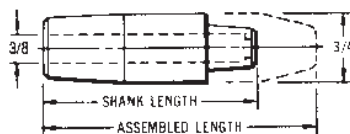

Shank Length	Assembled Length	Description	Part No.
1-1/2	2	TP-2606	163-2606
2	2-1/2	TP-2608	163-2608
2-1/2	3	TP-2610	163-2610
3	3-1/2	TP-2612	163-2612

'E' NOSE 4 AND 5 CAP  **'F' NOSE 4 AND 5 CAP** 

For improved cooling, female shanks are drilled through (to put water in contact with cap). Shanks may be ordered with a blind water hole, upon request.

BENT SHANKS FOR FEMALE CAPS (CLASS 2*)

SHANKS 4 RW TAPER

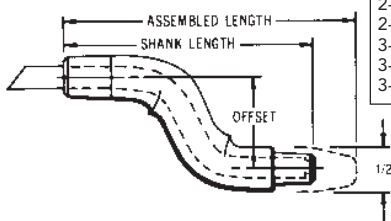

Shank Length	Off-set	Length	Description	Item No.
2-3/4	1/2	3-1/4	TP-2411-08	164-2442
2-3/4	3/4	3-1/4	TP-2411-12	164-2445
2-3/4	1	3-1/4	TP-2411-16	164-2447
3-1/4	1/2	3-3/4	TP-2413-08	164-2465
3-1/4	1-1/4	3-3/4	TP-2413-20	164-2480
3-1/2	1	4	TP-2414-16	164-2490

SHANKS 5 RW TAPER

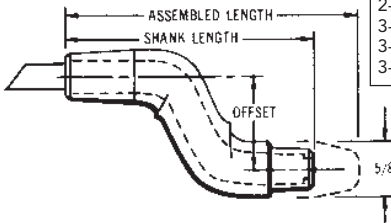

Shank Length	Off-set	Length	Description	Item No.
2-3/4	1/2	3-1/4	TP-2511-08	164-2542
2-3/4	3/4	3-1/4	TP-2511-12	164-2545
2-3/4	1	3-1/4	TP-2511-16	164-2547
3-1/4	1/2	3-3/4	TP-2513-08	164-2565
3-1/4	1	3-3/4	TP-2513-16	164-2570
3-1/4	1-1/4	3-3/4	TP-2513-20	164-2580

* Class 3 Available

FEMALE CAPS

POINTED TIPS 'A'

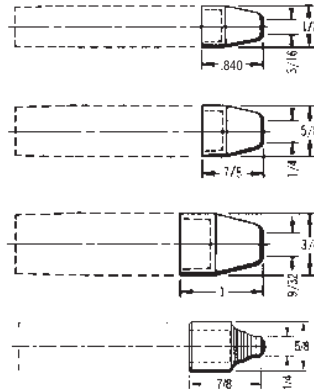

Alloy Class	Taper of Adapter Shank	Description	Part No.
2	4RW	TP-24A	125-0241
2 (Cu Cr Zr)	4RW	TP-24AZ	126-0241
2	5RW	TP-25A	125-0251
2 (Cu Cr Zr)	5RW	TP-25AZ	126-0251
2	6RW	TP-26A	125-0261
2 (Cu Cr Zr)	6RW	TP-26AZ	126-0261
Z	4RW	TP-24SZ	127-0241
Z	5RW	TP-25SZ	127-0251

Other sizes available

DOME TIPS 'B'

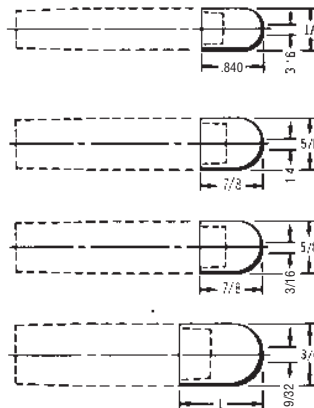

Alloy Class	Taper of Adapter Shank	Description	Part No.
2	4RW	TP-24B	125-0242
2 (Cu Cr Zr)	4RW	TP-24BZ	126-0242
2	5RW	TP-25B	125-0252
2 (Cu Cr Zr)	5RW	TP-25BZ	126-0252
2	5RW	TP-25B-20	125-0252.20
2 (Cu Cr Zr)	5RW	TP-25BZ-20	126-0252.20
2	6RW	TP-26B	125-0262
2 (Cu Cr Zr)	6RW	TP-26BZ	126-0262

FLAT TIPS 'C'

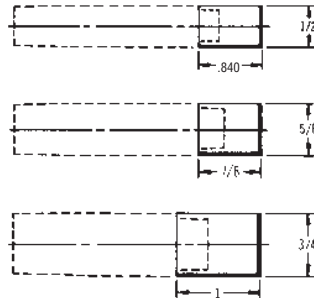

Alloy Class	Taper of Adapter Shank	Description	Part No.
2	4RW	TP-24C	125-0243
2 (Cu Cr Zr)	4RW	TP-24CZ	126-0243
2	5RW	TP-25C	125-0253
2 (Cu Cr Zr)	5RW	TP-25CZ	126-0253
2	6RW	TP-26C	125-0263

OFFSET TIPS 'D'

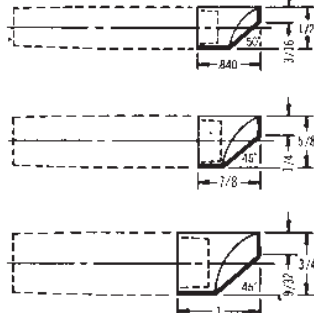

Alloy Class	Taper of Adapter Shank	Description	Part No.
2	4RW	TP-24D	125-0244
2 (Cu Cr Zr)	4RW	TP-24DZ	126-0244
2	5RW	TP-25D	125-0254
2 (Cu Cr Zr)	5RW	TP-25DZ	126-0254
2	6RW	TP-26D	125-0264

