

Southern Copper and Supply 800-289-2728

CHAMELEON/MAX-LIFE™ NUT WELDING ELECTRODES



Phone: 866-634-8884

Fax: 866-239-6995

Email: cmw@cmwinc.com

CHAMELEON/MAX-LIFE™ NUT WELDING ELECTRODES

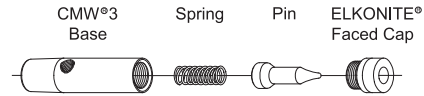

Nut Welding Assemblies	Nut Thread Size	Pin Dia. P	CMW®3 Base	Spring	Ceramic Coated Stainless Steel Pin	ELKONITE® Faced Cap
16-37725-04	#4	.142	16-37325	16-950078-01	16-950064-04	16-37725-C04
16-37725-05	#5	.158	16-37325	16-950078-01	16-950064-05	16-37725-C05
16-37725-06	#6	.173	16-37325	16-950078-01	16-950064-06	16-37725-C06
16-37725-M4	4MM	.187	16-37325	16-950078-01	16-950064-M4S	16-37725-CM4
16-37725-08	#8	.198	16-37325	16-950078-01	16-950064-08	16-37725-C08
16-37725-10	#10	.220	16-37325	16-950078-01	16-950064-10	16-37725-C10
16-37725-M5	5MM	.226	16-37325	16-950078-01	16-950064-M5S	16-37725-CM5
16-37725-12	#12	.250	16-37325	16-950078-01	16-950064-12	16-37725-C12
16-37725-M6	6MM	.266	16-37325	16-950078-01	16-950064-M6S	16-37725-CM6
16-37725-25	.250	.283	16-37325	16-950078-01	16-950064-25	16-37725-C25

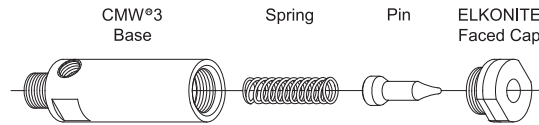
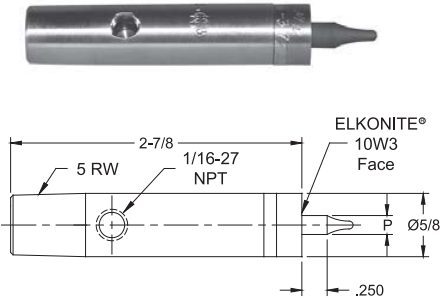

Nut Welding Assemblies	Nut Thread Size	Pin Dia. P	CMW®3 Base	Spring	Ceramic Coated Stainless Steel Pin	ELKONITE® Faced Cap
16-37825-M4	4MM	.187	16-37825	16-950065-01	16-950064-M4	16-37825-CM4
16-37825-M5	5MM	.226	16-37825	16-950065-01	16-950064-M5	16-37825-CM5
16-37825-M6	6MM	.266	16-37825	16-950065-01	16-950064-M6	16-37825-CM6
16-37825-M7	7MM	.305	16-37825	16-950065-01	16-950064-M7	16-37825-CM7
16-37825-M8	8MM	.344	16-37825	16-950065-01	16-950064-M8	16-37825-CM8
16-37825-M9	9MM	.384	16-37825	16-950065-01	16-950064-M9	16-37825-CM9

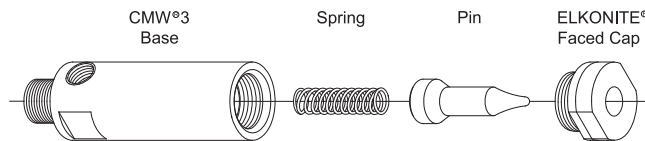
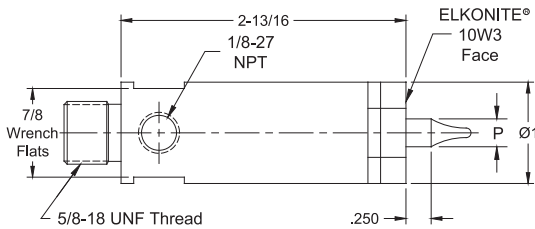

Nut Welding Assemblies	Nut Thread Size	Pin Dia. P	CMW®3 Base	Spring	Ceramic Coated Stainless Steel Pin	ELKONITE® Faced Cap
16-37826-M10	10MM	.423	16-37826	16-950065-01	16-950064-M10	16-37826-CM10
16-37826-M11	11MM	.463	16-37826	16-950065-01	16-950064-M11	16-37826-CM11
16-37826-M12	12MM	.502	16-37826	16-950065-01	16-950064-M12	16-37826-CM12
16-37826-M14	14MM	.581	16-37826	16-950065-01	16-950064-M14	16-37826-CM14

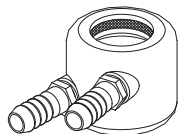
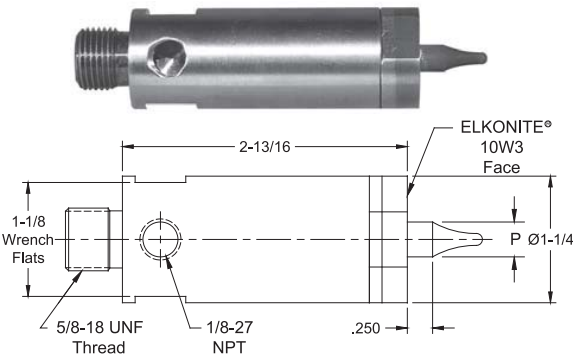

External Electrode Cooling Chamber

Electrode Dia.	Cooling Chamber Part No.	Tapered Adapter Part No.
5/8	18-1340	--
1	18-1342	18-7741
1-1/4	18-1343	18-7742

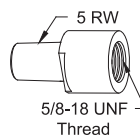

Tapered Adapter

- Electrode Assemblies 16-37825-XX and 16-37826-XXX may be used with 5/8-18 threaded holders 18-169, 18-170, 18-171, shown on page 32

- Electrode Assemblies 16-37825-XX and 16-37826-XXX may be used with Platen Mounted holders (page 61) by using adapter 18-7743 shown on page 31

All dimensions are in inches unless otherwise noted

Southern Copper and Supply 800-289-2728
CHAMELEON/MAX-LIFE™ STUD WELDING ELECTRODES



Phone: 866-634-8884

Fax: 866-239-6995

Email: cmw@cmwinc.com

CMW®3 Base	Sleeve	ELKONITE®
.116	16-953116	16-37325-C116
.132	16-953132	16-37325-C132
.140	16-953140	16-37325-C140
.169	16-953169	16-37325-C169
.169	16-953169	16-37325-C169
.191	16-953191	16-37325-C191
.204	16-953204	16-37325-C204
.220	16-953220	16-37325-C220
.243	16-953243S	16-37325-C243
.254	16-953254S	16-37325-C254

ELKONITE®
Faced Cap

ELKONITE®
Faced Cap

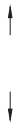

16 12MM
 16-37526-502
 16-37526-630 .625

Electrode Dia.	Cooling Chamber Part No.	Tapered Adapter Part No.
5/8	18-1340	
1		

External Electrode Cooling Chamber

